



TG300 ABS Owner's Manual



Royal Alloy



Preface

Thank you for choosing your Royal Alloy **TG300** scooter. Royal Alloy products embody high technology with reliability and have been designed utilising RA Engineering Co., Ltd and its partners' many years of experience in manufacturing scooters for travel, commuting, leisure and sporting activities. This is why this model takes a leading position in the market sector.

This manual explains the use, operation, basic inspection and maintenance etc for your scooter. If you have any further questions about the operation and maintenance, please contact your dealer.

The scooter is designed to fully meet the exhaust emissions standards prevailing on the date of manufacture.

To keep the compliance to the exhaust emissions standards, please carry out the maintenance schedule and instructions in this manual in cooperation with your dealer.

The following important information will appear in this manual:

 **Caution:**

Refer to procedures that must be followed. Otherwise, your personal safety may be endangered.

 **Note:**

Refer to procedures that must be followed to avoid damaging the scooter

 **Warning:**

Refer to procedures that must be followed to avoid injury to you, or other persons or damage to the scooter.

Note

This manual should be regarded as part of the scooter and should be always with the scooter, even when it is resold.

Note

Our company is working hard towards improvement of product design and quality. This manual contains the latest product information at the time of print. However, it is possible that the manual may have slight differences with your scooter. If you have any question, please contact your dealer.

 Warning

Read this manual carefully before riding the scooter.

Contents

Precautions for Safe Riding	6	Running-in of New Scooter	18
Names of Different Parts	7	Inspection before Riding	19
The Serial Number	9	Inspection of Braking effect and free play	20
Functions of Controllers	10	Inspection the Front Brake and Anti-Dive Linkage.....	20
Instrument Panel Indications	10	Inspection of the Tyres.....	20
Ignition Switch	11	Inspecting the Quantity of Fuel.....	21
Switches on the Handlebars(Left)	12	Inspecting the Quantity of Engine Oil	21
Switches on the Handlebars(Right)	13	Inspecting the Transmission Oil Level	22
Fuel Tank Cap	14	Inspection of the Ignition Unit and the Lights	22
Coolant tank cap	15	Riding Tips	23
Seat Lock(一)	16	Start the Engine	23
Front Luggage Box.....	16	Setting off.....	23
Fuel and Oil Recommendations	17	Inspection and Maintenance	25
Fuel	17	The first maintenance	25
Engine Oil.....	17	Maintenance Schedule	26
Transmission Oil.....	17	Battery	28
		Spark Plug	28

Fuel Hose.....	30
Air Filter	30
Tyres	32
Fuses	33
Troubleshooting	34
Storage Procedures.....	35
Specifications.....	36

Precautions for Safe Riding

Please obey all local traffic regulations and consider safety prior to riding. It is advised to control your speed and to stay within safe limits.

Practice before Riding

Before riding the scooter in traffic, it is recommended that you practice your riding at a spacious and traffic-free place so that you are skilled enough to ride safely and are familiar with the scooter's controls. Practice is essential for safety. Please observe any special training and or government test required before using your scooter on the public highways.

Knowing Your Safety Speed Limit

Safe speed limit varies in accordance with the road conditions, riding skill and the weather. Be aware of local and national speed limits.

Be Careful on Rainy Days

It is dangerous to ride on damp or wet roads. Therefore, high speed should be avoided and special care should be taken when turning. Bear this in mind, the braking distance on rainy days can be twice as much as on dry days.

Correct Wearing of Safety Helmet

Wear a safety helmet whenever you ride, and make sure you fasten the strap securely whenever you wear the helmet.

Safety clothing Recommendation

Bright-coloured and well-fitting garments are recommended. Mind that the clothes should allow the limbs to move freely.

Clothes of thick materials and shoes with short heels are also recommended.

Indispensable Maintenance and inspection

The following items are indispensable:

- ◇ Make safety checks before every journey.
- ◇ Half-yearly thorough inspection.
- ◇ One-year thorough serving.
- ◇ Those listed in the Maintenance

Caution High Temperature

The high temperature of the muffler may cause burns. Please park your scooter to prevent the accidental chance of persons coming into contact with the muffler.

No modifications allowable

Modification to the unit is not allowed and may not guarantee a safe driving.

Names of Different Parts

Read the following labels carefully before using the motorcycle.

1.Exhaust/Muffler pipe	4.Seat	7.Front turning lamps
2.Rear light/Brake light/number plate light	5.Acceleration grip &right switch	8.Side reflector
3.Rear rack	6.Head lamp	9.Front right shock absorber



 Warning

Rear rack has a maximum payload of 5 kgs

1. Rear brake lever	5. Rear indicator lamps	9. Main stand
2. Rear-view mirrors	6. Rear shock absorber	10. Side stand
3. Left grip switch	7. Rear disc brake	11. Front disc brake
4. Glove box	8. Air filter	12. Front left shock absorber

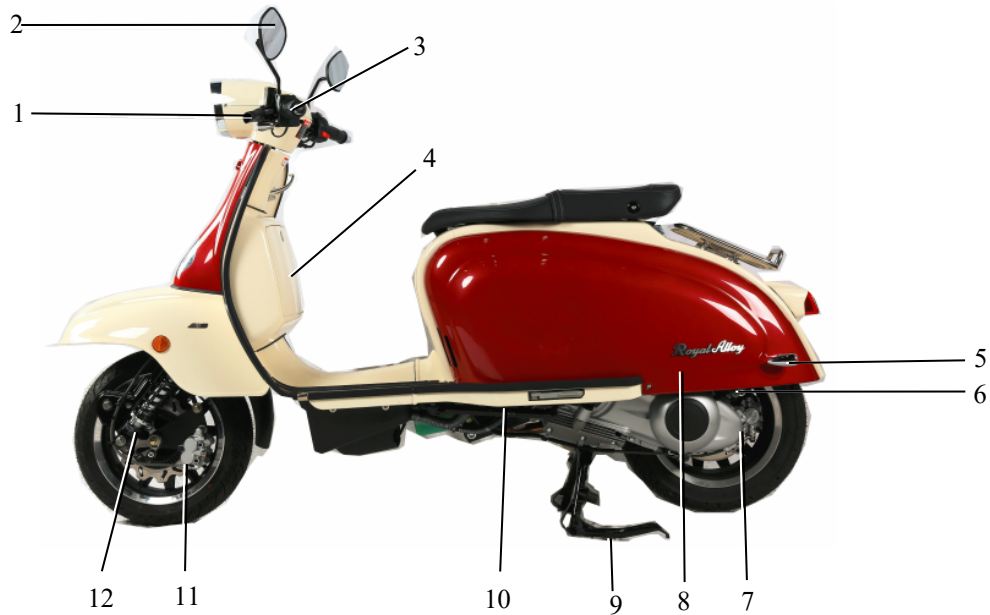

The Serial Number

Engine number

Engine number is stamped on the rear of the crankcase assembly.

Note

Remember your engine number in mind for convenience in purchasing correct spare parts from your distributor.

Chassis number

Chassis number is stamped on the frame right side frame rail.

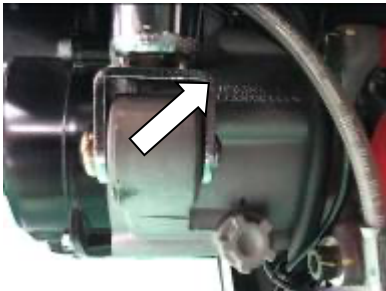

Engine number

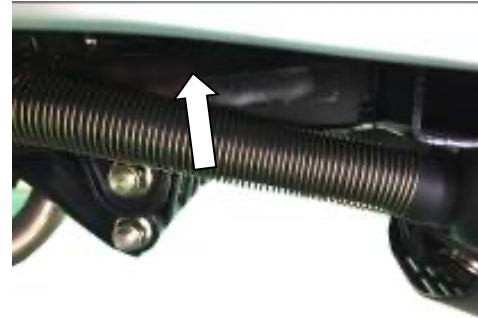

Chassis number

Please write down the serial numbers below for future reference.

Chassis Serial No. :

Engine Serial No. :

Functions of Controllers

Instrument Panel Indications

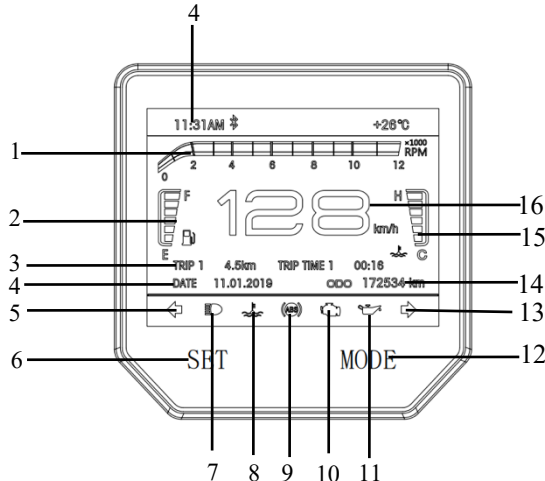

1 - Engine RPM Indicator

The indicator will show the engine RPM.

2 - Fuel gauge

This shows the fuel volume remaining in the fuel tank. When the pointer points to “F”, the fuel tank is full. When the pointer moves to “E” or lower, it means the fuel level is low and refilling is necessary.

3 – TRIP

The trip registers the single distance that the scooter has been ridden.

4 – DATE&TIME

Display the date & time.

5/13- LH Direction Indicator & RH Direction Indicator

When the turning switch lever is set to left, the LH Direction Indicator will flash. When the turning switch lever is set to right, the RH Direction Indicator will flash.

6/12 – LEFT&Right set button,functions (See below):

Short press the left button “SET” :KPH and MPH change.
Long press the Right button “MODE” :TRIP clear.

Long press the left button “SET” :

Long press the left key to enter the clock setting mode.

At this time, the month digit flashes. short press the right button “MODE” to adjust. short press the left button

“SET” to shift. set the month、 day 、year、 minute AM / PM in turn. after setting, long press the left button “SET” to save and exit. if there is no other operation more than 15s in this operation, it will automatically save and exit.

7 - High beam/ Low beam indicator

8 - Water temperature indicator

9 - ABS indicator

If this warning light appears during running please consult your dealer.

10 - Engine fault indicator warning light

If this warning light appears during running please consult your dealer.

11- Oil indicator

**STOP ENGINE* if this warning light appears during running check oil level if found to OK. Then please consult your dealer.*

14 – Odometer

The odometer registers the total distance that the scooter has been ridden.

15 - Water temperature gauge

16 – Speedometer

The speedometer shows the speed at which you are riding in MPH or KPH.

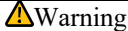
	Warning
Before open the ignition switch, To prepare an adequate battery, and connected firmly, can not have any loose.	

Ignition Switch

ON	The engine can be started. Possible to drive. It is not possible to remove the key.
OFF	The engine cannot be started. The engine is stopped. The key can be inserted or removed.
LOCK	The steering bars can be locked to one direction. The key can be inserted or removed.

Rotate the key to turn power ON or OFF.

When you leave the scooter, you may lock the steering handlebars to help prevent your scooter from being stolen.

1. Turn the handlebars to the left.
2. Insert the key (if it is not in the ignition) from OFF position. Press the key in and turn it anti-clockwise to LOCK position.
3. Pull out the key.

To unlocking the handlebars, insert the key from LOCK position, and turn it (without pressing) clockwise to OFF position.



	Note
✧	Rotate the handlebars to ensure that they are unlocked.
✧	Tip, you may turn the handlebars slightly rightward and try again.

Switches on the Handlebars(Left)



1. Beam Switch

This switch is used to change the headlamp beam. When you turn the switch to:

HIGH	The high beam is turned on.
LOW	The low beam is turned on. (Low beam is for normal riding)

2. Horn Button

Press this button to sound the horn.

3. Turning Indicator Switch

This switch is used to turn on/off the left/right indicators to show the other vehicles that you want to turn left or right. When you press the lever to:

Right	The right signal lamps flash.
Left	The left signal lamps flash.
Centre	Push in the switch at the centre position to cancel the turn-signal operation.

Please turn off the lamps when they are no longer necessary, otherwise you may cause problems to drivers in front of or behind you.

Switches on the Handlebars(Right)

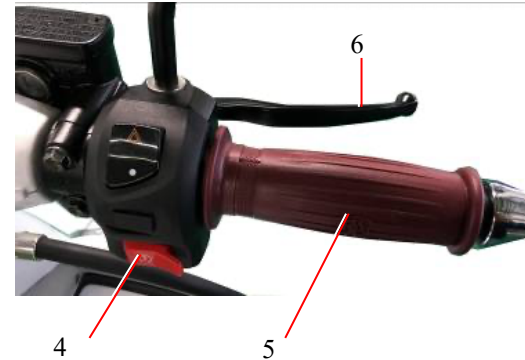

4. Starter Button

This button is used to start the engine. Turn the ignition key to ON, squeeze the rear brake lever (6) and press the button (4).

5. Throttle Grip

Throttle grip is used to control engine speed. Rotate it towards you to increase engine speed; Turn it away from you to decrease the engine speed.

6. Brake Levers

By operating the brake levers, you can control the

speed of the scooter to slow down or stop. The brake is applied by squeezing the brake lever gently towards the grip. The rear brake light will be illuminated when the lever is squeezed inward.

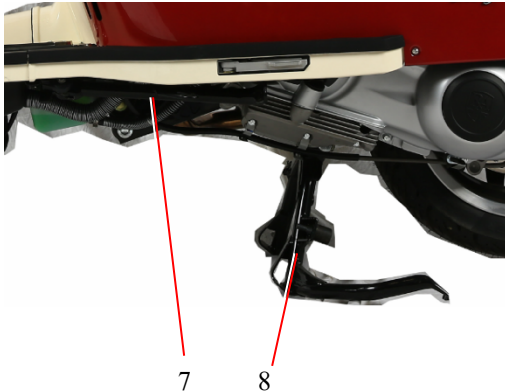

7. Side Stand

To use the side stand, depress the end of the stand until it rotates towards the front of the scooter and stops. Please note: If the side stand is not fully retracted the engine will not start.

8. Main Stand

To use the main stand, depress it by foot and lift the rear of the scooter backwards using the rear rack until the stand is securely in place with the rear wheel off the ground.

Fuel Tank Cap

To access the fuel cap open up the seat .To open the fuel cap, insert the ignition key into the cap and turn the fuel cap tab clockwise. Please note: Don' t use the key to rotate the cap as this make cause the key to break, shuold the key and lock cover were rotated at the same time. Close the fuel cap use the same way.

There has a Operation Notice deccal nerrby the fuel cap.

Operation Notice

When the key is inserted,the oil fillingport can be opened or closed unless the key and lock cover were rotated at the same time.



Coolant tank cap



The coolant tank cap is in the left of vehicle.

Note

When the key is inserted, the oil filling port can be opened or closed unless the key and lock cover were rotated at the same time.

⚠ Warning

- ❖ Never open coolant tank cap when the scooter is hot.
- ❖ Hot coolant can cause burns and may cause injury.

Seat Lock



To open and close the seat as follows:

1. The seat release button is located on the left hand side and to the rear of the seat, push the button in and the seat will open.
2. To close the seat gently lower the seat down onto the locking pin.

Front Luggage Box



	⚠ Caution
◇	Do not keep breakables in the luggage box.
◇	Do not keep valuable item in the luggage box.
◇	Do not place fuel and oil in the luggage box.
◇	Only store water proof items in luggage box

Fuel and Oil Recommendations

Fuel

Use unleaded fuel with an octane number Unleaded Euro 95 or higher. Unleaded fuel can extend spark plug life and exhaust component life. We recommend using the highest octane pump fuel available.

Engine Oil

Use of high quality 4-stroke engine oil will extend the longevity of the engine. Grade SE or SD engine oil in API method are recommended with a viscosity of SAE10W-40. If this oil is not available, please purchase appropriate substitutes according to the data listed below.

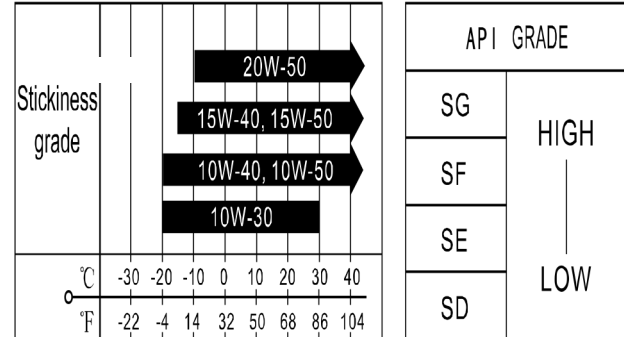

Transmission Oil

Use good quality SAE 75W-80 synthetic motor oil.

Specifications – API, GL4, GL5

Running-in of New Scooter

The first 600 miles (1000km) are the most important in the life of your scooter. Correct running-in operation during this period will help ensure maximum life and performance from your new scooter. The parts are manufactured from high quality materials, and machined parts are finished to close tolerances. Correct running-in operation allows the machined surfaces to lap each other and bedding together smoothly. Freeing up of the internal parts is achieved after approximately 60 running hours, and during this running-in period the engine will loosen up and performance will improve.

Maximum Throttle Operation Recommendation

This table shows the maximum recommended throttle operation during the break-in period. Change below to miles

Initial 100 miles (160 km)	Less than 1/2 throttle
Initial 250 miles (400 km)	Less than 3/4 throttle

Vary the engine Speed

The engine speed should be varied and not held at a constant speed. This allows the parts to be “loaded” with pressure, and then unloaded, allowing the parts to cool. This aids the bedding together process of the parts. It is essential that some stress should be placed on the engine component during running-in to ensure this bedding together process. Do not, apply extensive load on the engine during this period.

Avoiding Constant Low Speed

It is not beneficial when running in the engine to operate it at a constant low speed. Allow the engine to accelerate freely within the recommended maximum limits. Do not, however, use full throttle for more than 10 minutes during the first 1000 miles (1600km).

Allow the Engine Oil to Circulate before Riding

Allow sufficient idling time after warm or cold engine start up before applying load or revving up the engine. This allows time for the lubricating oil to reach all critical engine components.

Performing the First Service

The 600 miles (1000 km) service is the most important service your scooter will receive. During running-in all of the engine components will have bedded together and all the other parts will have seated in. All adjustments will be restored, all fasteners will be tightened, and the old oil will be replaced. Timely performance of the 600 mile6 (1000km) service will ensure optimum service life and performance from the engine.

Caution

The 600 miles (1000km) service should be performed as the outlined in the inspection and maintenance section in this manual. Pay attention to the caution and warning in that section.

Inspection before Riding

Before riding the scooter, be sure to check the following items. Never underestimate the importance of these checks. Perform all of them before riding the machine.

 Warning	
Ensure that the battery is fully charged and that the battery is secure and the battery terminals/connectors are secure. A battery with loose connections will damage electrical components including the ECU.	
WHAT TO CHECK	CHECK FOR
Steering	<ol style="list-style-type: none"> 1) Smoothness 2) No restriction of movement 3) No play or excessive movement
Brakes	<ol style="list-style-type: none"> 1) Correct brake lever free play 2) No obstruction in braking.
Tyres	<ol style="list-style-type: none"> 1) Correct pressure 2) Adequate tread depth 3) No cracks or cuts
Fuel	Enough fuel for the planned distance of the journey
Lighting	Operate all lights — headlamp, side lamp, tail lamp, brake lamp, turning indicator lamps

Indicators	Oil level indicators (if fitted) and turning indicators
Horn	Correct function
Engine oil Lubricants	Check to ensure the correct level
Throttle	1) Correct play in the throttle cable 2) Smooth operation and positive return of the throttle grip to the closed position when released

Inspection of Braking effect and free play

Hold the brake levers until feeling resistance, measure the moved distances at the lever ends. The distances should be 10~20mm.

Inspection the Front Brake and Anti-Dive Linkage

Check the anti-dive link bar has free movement by twisting from side to side. If any excessive play is found in the up and downward movement, remove and inspect/replace as required.

Inspection of the Tyres

1. Tyre Pressures

Observe the wear condition of the tyre and determine the tyre pressure. If the tyre pressure is abnormal, check it with a tyre pressure gauge and adjust it to the correct value.

Inflation Tyre Pressure (cold) – UK and Europe

(Specification may alter in warmer climates)

Front Wheel	32psi
Rear Wheel	34psi

2. Crack, Damage, Foreign Object and Abnormal Wear

Check the surface of the tyre:

- ✧ Is there any obvious damage?
- ✧ Are there any nails, stones, glass etc. in the tyre or in the tread?
- ✧ Is there any abnormal wear?

Inspecting the Quantity of Fuel

Make sure that the fuel is sufficient to reach your destination. Turn the ignition switch to ON position, if the fuel gauge hands points to the red region, the fuel should be refilled as soon as possible.

Inspecting the Quantity of Engine Oil

Cautions always ensure the oil level is kept at the upper level mark “B” on the engine oil dipstick. Never allow the oil level to exceed the upper marker or fall below the lower mark “C” or this will cause severe engine damage.

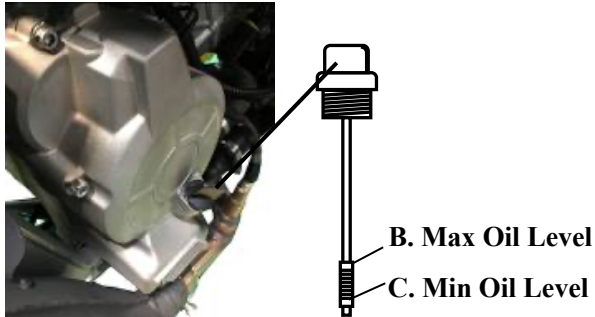

1. Keep the vehicle in an upright and level position.
2. Start the engine, let it idle during a few minutes and then switch it off.
3. Wait at least five minutes to let the oil that is inside the engine to run back down into the crankcase.
4. Loosen the refilling oil cap/dipstick and remove.
5. Clean the dipstick of oil residues, insert the oil filler cap but don't screw in, otherwise there will be a wrong measurement, which may lead to engine damage. Remove again and check for the correct oil level it must be between the reference marks “B” and “C”.
6. If necessary, refill to the “B” level, taking into account that it should not exceed the “B” mark.
7. Refit the dipstick securely

Inspecting the Transmission Oil Level

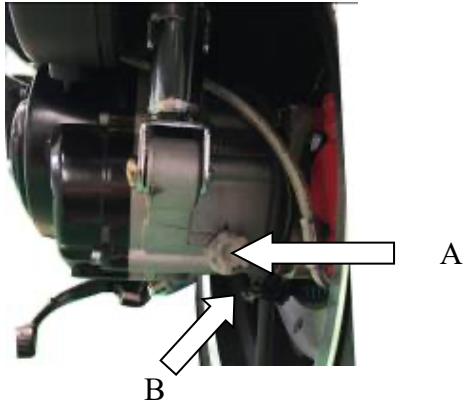

1. Stop the warmed-up engine; wait for approx.5 minutes.
2. Prop up the scooter on the main stand.
3. Remove the oil filler screw (A) and check if the oil level is below the oil filler opening.
4. If required, replenish transmission oil Hypoid SAE 80W - 90 via the oil filler opening.
5. When changing transmission oil, open the drain plug (B) until all transmission oil flows out then tighten the plug (B) and add new oil via the oil-filler opening.
6. Tighten the oil filler screw (A).

Inspection of the Ignition Unit and the Lights

Start the engine, and check if the headlight and the rear lights are on.

Operate the front and rear brake separately, and check if the brake light is activated.

Operate turning indicator switch, and check if the turn signal indicator lights are working normally. Inspecting the Rear View Mirrors

Check to see if objects to the rear and both sides can be seen clearly from the rear view mirrors when seated in the rider's normal position.

Check if the rear mirror is clean and free from damaged check tightness on the handlebar mounting.

Inspecting the Reflectors and the License Plate

Check that the license plate and the reflectors are not dirty or damaged.

Check that the license plate is fixed securely and that the registration number is clearly visible.

Riding Tips

Caution

Before starting, you must

1. Check the quantity of fuel and engine oil.
2. Place the scooter onto the main stand.
3. Ensure that the machine is on flat, hard ground.
4. Apply brakes

Start the Engine

Insert the ignition key into the ignition switch and rotate it to ON position

When the engine is cold:

- Squeeze the rear or front brake lever keep the throttle closed.
- Push the starter button or depress the kick starter lever.
- As the engine starts apply a small amount of throttle and let the engine warm up after being started.
-

When the engine is warm:

- Squeeze the rear or front brake lever.
- Open the throttle 1/8~1/4.
- Push the starter button

Caution

Release the starter button soon after the engine is started. Otherwise damage may result to and starter motor and gear wheels.

If the engine remains un-started after several attempts, turn the throttle grip by 1/8~1/4 and try again. The grip should be released soon after the engine is started.

Setting off

Release the main stand and mount the scooter.

While holding the handlebars with both hands, remove the scooter from the main stand. With both brakes applied mount the scooter from left side and sit on the seat. Support yourself with your left foot.

Caution

No turning of the throttle grip is advised before you are ready to set off.

Look around to see ensure that it is safe to set off.

Activate your appropriate turning indicator. Look around to judge the conditions are safe to set off. Keeping the rear brake lever squeezed until you are ready to set off.

	 Caution
Special attention should be paid to the traffic approaching you from behind.	

Setting off

Release the rear brake lever and gradually rotate the throttle grip towards you to let the scooter speed up slowly.

	 Caution
Excessive rotation of the grip can lead to the danger of sudden acceleration	

Adjust Speed

The speed of your scooter can be adjusted by turning the throttle grip. Rotate the grip towards you to speed up (anti clockwise). Gradual rotation is recommended. Rotate it back clockwise it to slow down (clockwise).

Apply Brakes

Combined application of both brakes is recommended.

Quickly release the throttle grip or rotate backwards (clockwise) to the minimum position and squeeze the brake levers simultaneously.

It is advisable to reduce the speed by gradual application of the brakes.

	 Caution
Single braking of the front or rear wheel may cause the danger of a side slide. Harsh braking or sharp turning are one of the major causes for loss of traction or crashes, and should therefore be avoided.	

Special care should be taken in rainy and wintery conditions.

Damp or wet road surfaces may reduce the level of grip. Sharp turning during acceleration should be avoided. An appropriate distance should be kept from the vehicles ahead. Please be mindful that the braking distance on rainy days can be twice the distance as

those on a dry day.

Skidding may occur on wet or slippery roads, therefore concentrate and be ready to apply the brakes cautiously at any time.

Check the brakes after washing the scooter or riding through water.

After washing the scooter or riding through standing water, the braking effect may be reduced. If this occurs, slow riding and gentle braking should be observed to allow time for the brakes to restore to their normal function.

Caution

To prevent your scooter from falling off the main stand never park your scooter facing downhill or on a loose or soft surface.
Always park the scooter on a hard flat surface or facing uphill.

Lock the handle bar

When you park the scooter, lock the handle bar to help protect your scooter from theft.

Inspection and Maintenance

The maintenance schedule indicates the intervals between periodic services in miles and months. At the end of each interval, be sure to inspect, check, lubricate and service as instructed. If your scooter is used under heavy load conditions such as continuous full throttle operation or is operated in a dusty climate, certain services should be performed more often to ensure reliability of the machine as explained in the maintenance section. The dealer can provide you with further guidelines. Steering components, suspension and wheel components are key items and require very special and careful servicing. For maximum safety we suggest that you have these items inspected and serviced by your dealer or a qualified service mechanic.

The first maintenance

The maintenance after first 600 miles (1000km) is the most important. During running in, all engine parts will have been matched to each other, bedding in will have occurred with other parts. All parts should be readjusted; all fasteners retightened and contaminated engine oil and filters replaced.

To ensure the engine a long service life and a good performance, carry out the 600 miles (1000km) maintenance as soon as it is due.

 Caution
We suggest you use genuine replacement parts or their equivalent. Even if you are an expert do-it-yourself mechanic, we recommend that those items on the maintenance schedule marked with an asterisk (*), be performed by the authorised dealer or qualified service mechanic. You may perform the unmarked items easily by referring to the instructions in this section.

Maintenance Schedule

The table below indicates the most important aspects, which should be carried out per maintenance

Key to the Abbreviations I: INSPECT & CLEAN, ADJUST, LUBRICATE OR REPLACE IF NECESSARY

C: CLEAN,

R: REPLACE, **A:** ADJUST, **L:** LUBRICATE

* Check level every 1,800 miles/3,000 km

** Replace every 2 years

*** Replace every 4 years

	600 miles (1000 km)	3700 miles (6000 km)	7400 miles (12000 km)	11200 miles (18000 km)	14800 miles (24000 km)	18600 miles (30000 km)	22300 miles (36000 km)	26000 miles (42000 km)	29800 miles (48000 km)	33500 miles (54000 km)	37300 miles (60000 km)
Torque driver pins			L		L		L		L		L
Safety fasteners	I		I		I		I		I		I
Plastic sliders in variator cover			R		R		R		R		R
Clutch bell		C	C	C	C	C	C	C	C	C	C
Spark plug			R		R		R		R		R
Driving belt			R		R		R		R		R
Throttle control	A		A		A		A		A		A
Air filter		C	C	C	C	C	C	C	C	C	C
Transmission cover air duct			I		I		I		I		I
Engine oil filter	R		R		R		R		R		R
Valve clearance			A		A		A		A		A
Braking systems	I	I	I	I	I	I	I	I	I	I	I
Electrical system and battery	I		I		I		I		I		I
Brake fluid **	I		I		I		I		I		I
Coolant level**	I		I		I		I		I		I
Gear oil	R		I		R		I		R		I
Engine oil*	R	I	R	I	R	I	R	I	R	I	R
Headlight aiming adjustment			A		A		A		A		A
Variator rollers			R		R		R		R		R
Vehicle road test	I		I		I		I		I		I
Variator front movable			I		I		I		I		I
Radiator	I/C	I/C	I/C	I/C	I/C	I/C	I/C	I/C	I/C	I/C	I/C
Wheels/tyres	I	I	I	I	I	I	I	I	I	I	I
Suspension			I		I		I		I		I
Steering	I		I		I		I		I		I
Transmission			L		L		L		L		L
Fuel pipes ***	I		I		I		I		I		I
Anti-dive linkage bearings	I	I	I	I	R	I	I	I	I	R	I

Bolts and nuts on frame body

Tighten the bolts and nuts to specified torque after initial 600miles (1000km) (3 month) and every 2,485 miles (4,000km) (20 month).

Specified torque

No.	Item	Nm	Kg/m	Reference
1	Front axle nut	53	5.3	/
2	Handlebar mounting bolt	49	4.9	/
3	Steering stem lock nut	30	3.0	/
4	Handlebar locating bolt	25	2.5	/
5	Front fork mounting bolt	45	4.5	/
6	Master cylinder mounting bolt	10	1.0	/
7	Brake hose union bolt	23	2.3	/
8	Brake calipers mounting	26	2.6	/
9	Bleeding valve	7.5	0.75	/
10	Front panel bolt	23	2.3	/

No.	Item	Nm	Kg/m	Reference
11	Rear axle nut	100	10.0	/
12	Rear shock bolt	40	4.0	/
13	Rear brake lever nut	11	1.1	/
14	Engine bracket mounting bolt/nut	98	9.8	/
15	Engine mounting bolt/nut	80	8.0	/
16	Anti Dive lever assembly	26	2.6	/

Battery

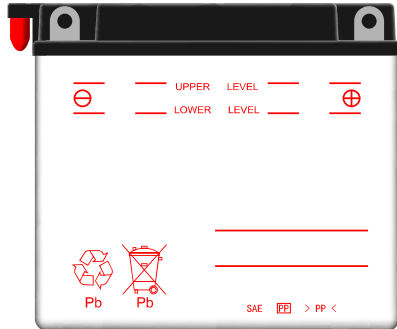

The battery is located inside the removable cover on the body sect beneath the front of the seat. This battery is the sealed type and requires no maintenance such as fluid level and gravity.



Spark Plug

Removal and Cleaning

Unscrew and remove the three screws, then remove left hand side panel which will gives access for removal of spark plug.

Caution

BEFORE CARRYING OUT THE FOLLOWING OPERATIONS AND IN ORDER TO AVOID RISKS OF BURNS, LEAVE ENGINE AND SILENCER TO COOL TO AMBIENT TEMPERATURE

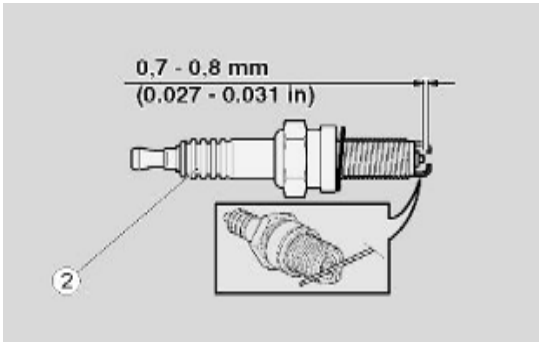

Remove the sparkplug suppressor cap (shown no.1) from the spark plug (shown no. 2)

Clean off any trace of dirt from the spark plug base by using

compressed air. Then unscrew it using the spanner supplied in the toolkit and remove it from the engine, cylinder being careful not to let dust or any other substance enter into the cylinder.

Check that the spark plug electrode and centre porcelain are free of carbon deposits or signs of corrosion. If necessary, clean using suitable spark plug cleaners, a wire and/or metal brush. Blow with a strong air blast to avoid removed dirt getting into the engine. Replace the spark plug if there are any cracks on the spark plug insulating material, corroded electrodes or several deposits.

Check the electrode gap with a feeler gauge. This gap should be 0.7 - 0.8 mm; adjust it if necessary by carefully bending the ground electrode.

Make sure the washer is in good conditions. Once the washer is fitted, manually screw the spark plug into the engine cylinder avoiding damaging the thread.

Tighten using the spanner supplied in the toolkit; make the spark plug is correctly tightened then an additional 1/2 of a turn to compress the washer.

⚠ Caution

TIGHTEN THE SPARK PLUG CORRECTLY. OTHERWISE, THE ENGINE MAY OVERHEAT AND BE DAMAGED. USE ONLY THE RECOMMENDED TYPE OF SPARK PLUG; OTHERWISE, ENGINE DURATION AND PERFORMANCE COULD BE COMPROMISED.

Standard spark plug

NGK PMR9B

Spark plug electrode gap

0.7 - 0.8 mm

Locking torques (Nm)

Spark plug (1) 10 Nm (7.38 lb ft)

Ensure that the spark plug suppressor cap is fitted securely, so that it will not get detached when exposed to engine vibrations.

Fuel Hose

Replace the fuel hoses every four years.

Air Filter

The air filter element used in this scooter is a polyurethane foam element. If the filter element has become clogged with dust, intake resistance will increase with a resultant decrease in power output and increase in fuel consumption due to the richer fuel/air mixture. Check and clean the air filter element according to the following procedure.

- Remove the screws.
- Remove the two fixing slippers by sliding them rearward.
- Remove the air filter cover.
- Remove the filter element.

Washing the Air Filter Element

Wash the air filter element as follows:

- Fill a container of a suitable size with non-flammable water soluble cleaning solvent. Immerse the filter element in the solvent and wash it clean.

Inspection and Maintenance

- Squeeze the solvent out of the washed filter element by pressing it between the palms of both hands. Do not twist and wring the filter element as this will lead to tearing.
- Rinse in warm free running water and allow to dry by using compressed air or warm air dryer.
- Immerse the filter element in clean engine oil, squeeze excess oil from the filter element to leave it slightly wet with the oil.
- Reinstall the cleaned air filter element in reverse order of removal. Be absolutely sure that the filter element is securely in position and is sealing properly.

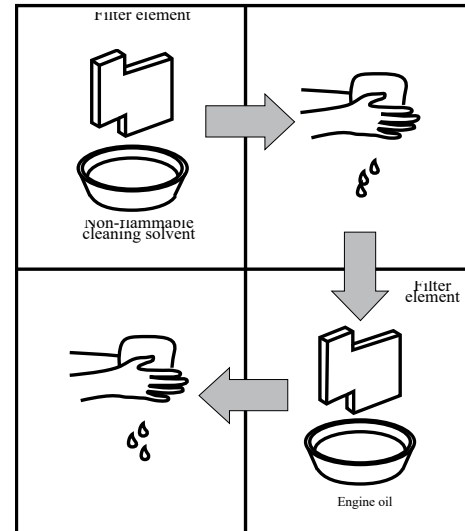

Caution

Before and during the cleaning operation, carefully examine the air filter element for any tears in the material. A torn filter element must be replaced with a new one.

If driving under dusty conditions, the filter element must be cleaned more frequently.

NEVER OPERATE ENGINE WITHOUT THE FILTER ELEMENT.

Operating the engine without the filter element will increase engine wear.

Always be sure that the filter element is in excellent operational condition at all times. The life of the engine depends largely on this single component.

Engine Idle Speed Adjustment

Start up the engine and warm it up.

- After engine warms up, turn the throttle stop screw in or out so that engine runs at 1500~1,800rpm.
- If you have a tachometer, you can do this adjustment by referring to the procedures described above. The engine idle speed should be adjusted after the engine warms up.

Throttle Cable Adjustment

Loosen the lock nut.

- Adjust the cable slack by turning adjuster in or out to obtain the correct slack of 0.5~1.0mm.
- After adjusting the slack, re tighten the lock nut.

Hydraulic Brake Fluid

For front and rear disk brake model

Grade: DOT4.1

Note: Only DOT4.1 glycol-based hydraulic brake fluid is suitable in this vehicle.

Don't mix it with silicon-based or oil-based fluid - otherwise the hydraulic brake system will be damaged.

Don't use residual fluid in the container opened during last maintenance, because it can absorb moisture from the atmosphere.

Do not over fill or spill the brake liquid onto the surface of paint or any surface.

Tyres

Check the tyre inflation pressure and tyre tread condition. For maximum safety and good tyre life, the tyre pressures should be inspected on a regular basis particularly before long journeys or with passengers.

Tyre Pressure

Insufficient air pressure in the tyres not only increases tyre wear but also seriously affects the stability of the scooter. Under inflated tyres make smooth cornering difficult and over inflated tyres decrease the amount of tyre in contact with the ground, which can lead to skids and loss of control. Be sure that the tyre pressure is within the specified limits at

all times. Tyre pressure should only be adjusted when the tyres are cold.

Cold inflation tyre pressure

UK and Europe (specification may alter in warmer climates)

Front Wheel	32psi
Rear Wheel	34psi

⚠Caution

Tyre inflation pressures and the general tyre conditions are extremely important for proper performance and safety of the scooter. Check your tyres frequently for both wear and correct inflation pressures.

Tyre Tread Condition

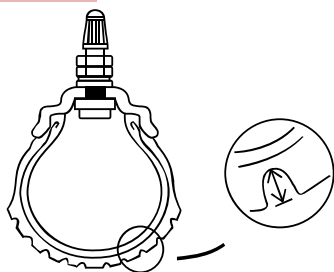

Operating the scooter with excessively worn tyres will decrease riding stability and may lead to loss of control. It is recommended that a tyre be replaced when the remaining depth of tyre tread becomes 1.6mm or less.

⚠Caution

The standard tyres on your scooter are 110/70/12 front and 120/70/12 rear. The use of a larger tyre other than standard may result in clearance issues.

Fuses

The fuses are located under the left hand side panel. If there is any electrical system failure, first check the fuse. In case the fuse is blown, there is a 10A spare fuse.

⚠Caution

Always be sure to replace the blown fuse with the correct amperage fuse. Never use substitute, for example aluminium foil or wire, to replace a blown fuse. If the spare fuse installed blows in a short period of time, it means that you could have a major electrical problem. You should consult the dealer or a qualified service mechanic immediately.

Troubleshooting

If the engine refuses to start, perform the following inspections to determine the cause.

Check the side stand has been fully retracted

Check that the battery has sufficient power to start the engine

Is there enough fuel in the fuel tank?

Caution

Do not allow the fuel to spill. Do not allow any fuel to come in contact with the hot engine or exhaust or ignition system. Extinguish any smoking materials from any other fire or heat source.

Remove the spark plug and re-attach it to the spark plug lead.

While holding the spark plug firmly against the engine, crank the engine with the ignition switch in ON position. If the ignition system is operating properly, a blue spark should jump across the spark plug gap. If there is no spark, consult the dealer for repairs.

Caution

Do not hold the spark plug close to the open spark plug hole in the cylinder head as gasoline vapour inside the cylinder could be ignited, creating a fire hazard. To reduce the chance of electrical shock, hold the outer steel shell of the spark plug against an unpainted metal portion of the engine. Due to the possibility of electrical shock, anyone with a heart condition or pacemaker should avoid this check.

Engine Stalling

- Check the fuel supply in the fuel tank.
- Check the engine idle speed.
- Check the ignition system for intermittent spark.

Caution

It is best to consult the dealer before attempting to troubleshoot any problem. If the machine is still within the warranty, then the dealer should definitely be consulted before you attempt any repairs on the machine. Tampering with the machine by you while in warranty may affect warranty consideration.

Storage Procedures

If the motorcycle is to be left unused for extended period of time for winter storage or any other reason, the machine needs special servicing requiring appropriate materials, equipment and skill, For this reason, we recommend that you trust this maintenance work to the dealer. If you need to service the machine for storage yourself, follow the general guidelines below:

Scooter

Place the motorcycle on its main stand and thoroughly clean the entire scooter.

Fuel

Drain the fuel tank.

Battery

Remove the battery from the scooter.

Clean the outside of the battery with mild detergent and remove any corrosion from the terminals and wiring harness connections. Store the battery in a room above freezing and connect a suitable battery trickle charger/ conditioner.

Tyres

Inflate the tyres to the normal specifications. See page 22/37

External

Spray all vinyl and rubber parts with rubber preservative.

Spray the unpainted surfaces with rust preventative such as WD40.

Coat the painted surfaces with a good high quality vehicle wax.

Please note: We suggest that you perform this task upon purchasing you new Royal alloy Scooter as part of your regular care and maintenance.

Procedure for Returning to Service

Clean the entire scooter.

Re fuel with normal unleaded fuel

Reinstall the fully charged battery.

Adjust the pressure of tyres as described in the TYRE section. Page 22/37

Lubricate all places as instructed in this manual.

Carry out the INSPECTION BEFORE RIDING as listed in this manual.

Specifications

Engine: 1 cylinder, S, horizontal, 4 Valve, second air intake

Model	TG300
Overall size (mm)	1845×670×1115
Wheel base (mm)	1390
Net weight (Kg)	152
Max loading weight(kg)	340
Fuel tank capability (L)	10.5
Engine model	1P75MN
Engine idle speed	1700 ±100 rpm
Engine type	1 cylinder, 4 Valve, Liquid cooling
Bore × stroke (mm)	75×63
Total displacement (ml)	278
Compression ration	11:1
Max net power, rate (kW/r/min)	16.0/7250
Max net torque, rate (Nm/r/min)	23.0/6000
Start mode	Electric
Engine oil(950ml)	SAE 10W-40
Lubrication type	Pressure/splash
Transmission oil 170ml	75W-80
Fuel type	Octane rating of 95 or higher

Tyre type	
Front tyre size	110/70-12
Rear tyre size	120/70-12
Inflation:	
Front	32 PSI
Rear	34 PSI
Front brake	Disc brake
Rear brake	Disc brake
Spark plug	NGK PMR9B
Head lamp	12V 35/35W or LED
Turning lamp	12V LED
Taillamp/Brake lamp	12V LED
Instrument indicator	12V 3W
Battery capacity	12V 9Ah
Fuse	10A
Horn	12V1.5A, 90-100dB(A)
Max noise	≤7m ≤82dB(A)

MEMO:

.....

.....

.....

.....

.....

.....

.....

.....

.....

.....

Owner's Manual



RA Engineering Co., Ltd



A Real Classic



Royal Alloy
www.royalalloy.com

TG300 ABS
Owner's Manual